

EJERCICIO NO. 1

- 1- Observe durante dos minutos esta figura.
- 2- Cierre los ojos e imagínese la durante unos instantes.
- 3- Copie la figura en el recuadro de al lado.

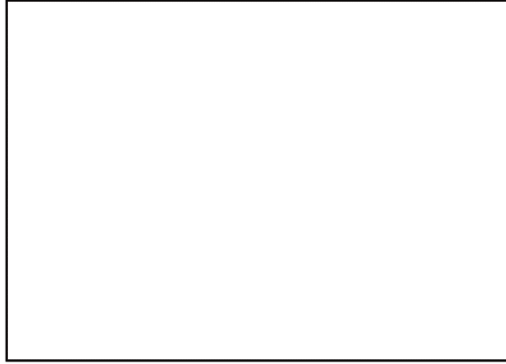

- 4- Haga lo mismo con las siguientes figuras.

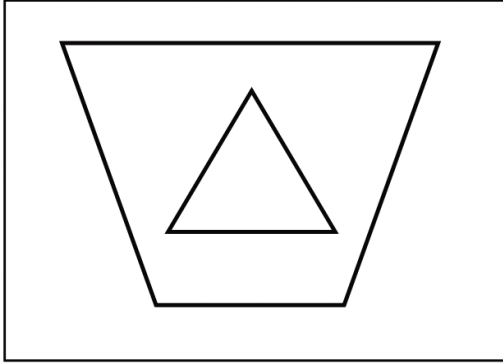
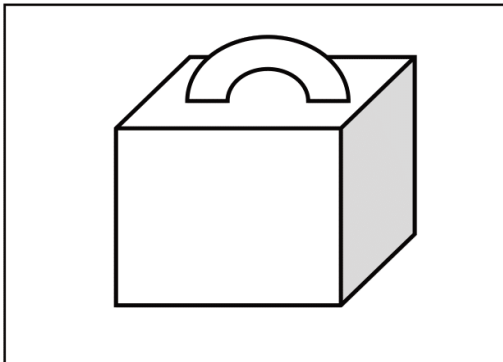
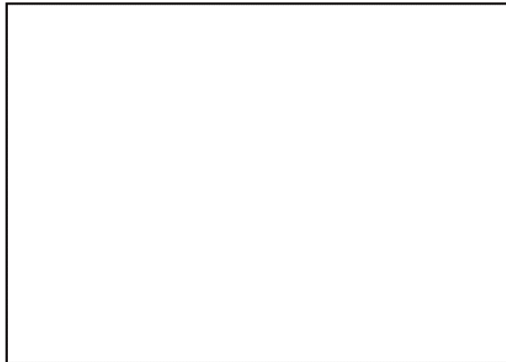
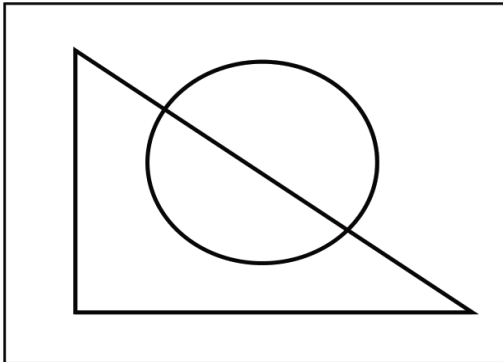



Referencias: www.esteve.com











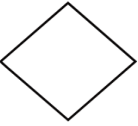

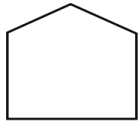
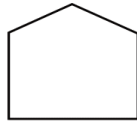

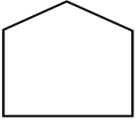
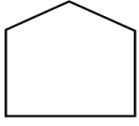
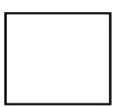
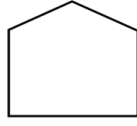
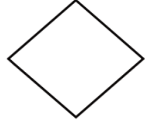
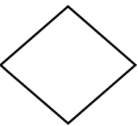

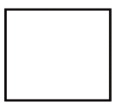
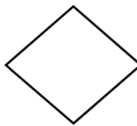
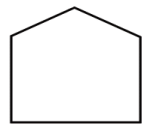
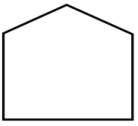
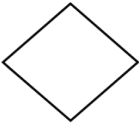
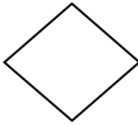
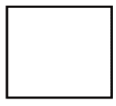
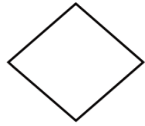
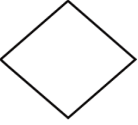
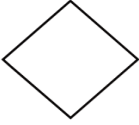
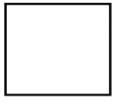
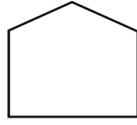

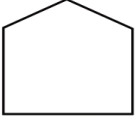
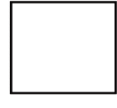
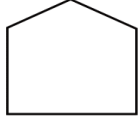
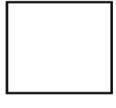
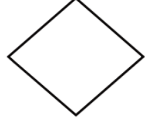
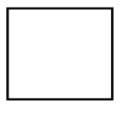
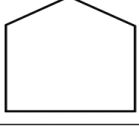
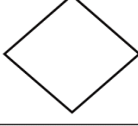
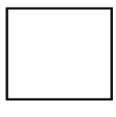
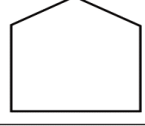





Más información en:

facebook

EJERCICIO NO. 2

Ejercicio de percepción

Cuente el número de formas ,  y  que hay en cada columna.

				
				
				
				
				
				
				
 =	 =	 =	 =	 =
 =	 =	 =	 =	 =
 =	 =	 =	 =	 =

Referencias: www.esteve.com



Más información en:

facebook

www.centrodiurnodeeltejar.org

EJERCICIO NO. 3

COLOREAR LAS MARIPOSAS. LAS IGUALES CON LOS MISMOS COLORES

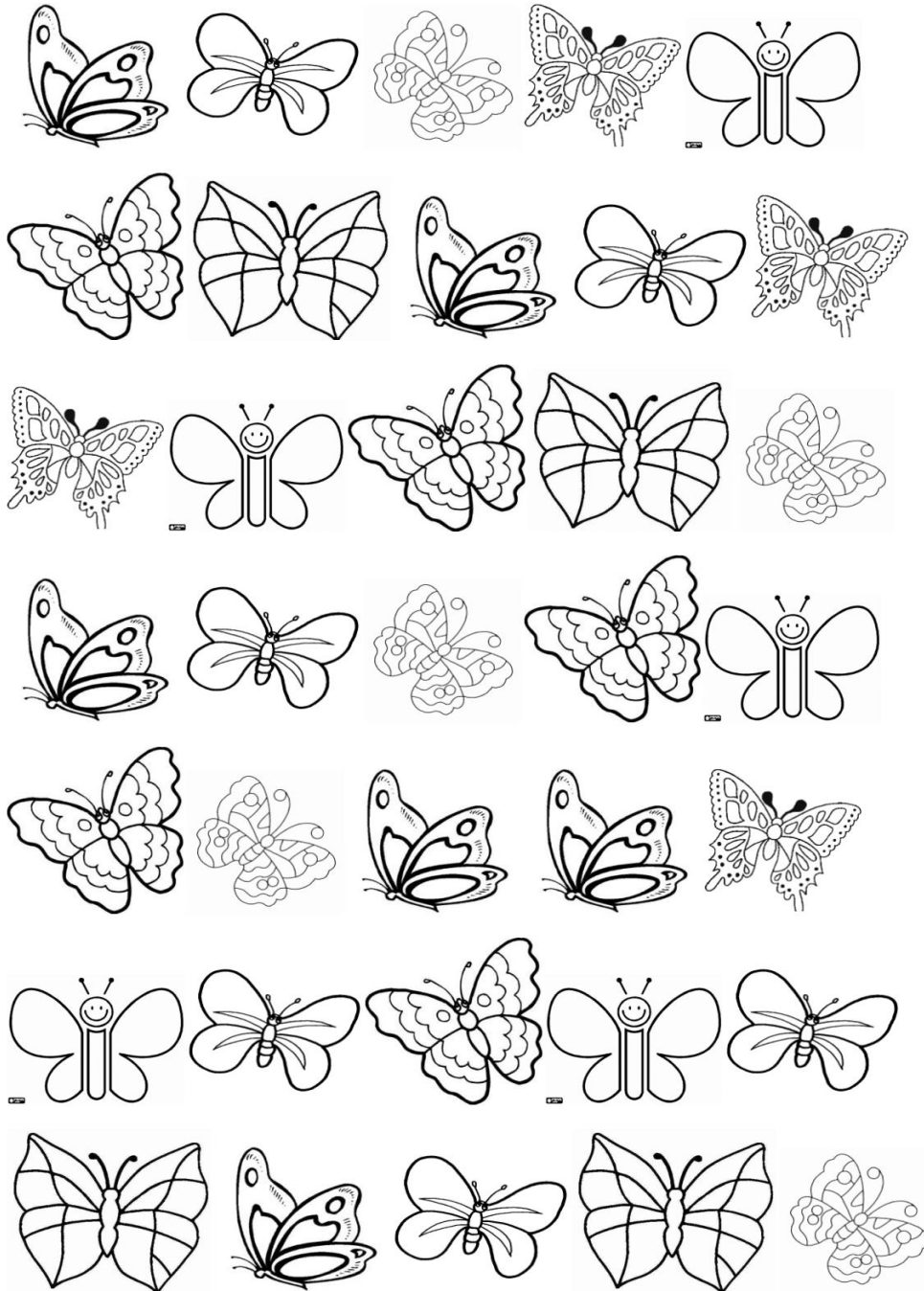

Referencias: Francisca Salas Baena

Más información en:

facebook

EJERCICIO NO. 4

Instrucción:

7 - Debajo de ☹️ ponga un 1 y debajo de 😊 ponga un 2.

😊	☹️	😐	😊	☹️	😊	😊	😐	☹️	😐
2	1								
☹️	😐	😊	☹️	😐	😊	😐	☹️	☹️	😐
😊	😊	☹️	😐	😊	☹️	😊	😊	😐	😊
☹️	😊	😐	☹️	😐	😊	😐	☹️	😊	😐

Sume los números. TOTAL ☹️ :

TOTAL 😊 :

Referencias: <http://www.sandozfarma.es/>



Más información en:

facebook

www.centrodiurnodeeltejar.org

EJERCICIO NO. 5

INSTRUCCIONES

Encierre con un Cuadrado ■ todos los números 8
Encierre con un Circulo ● todos los números 9

9 9 9 9 9 9 9 9 9 9 9 9 8 8 8 9 9 9 8 9 8
8 9 8 9 8 9 8 9 8 9 9 9 9 9 9 9 9 9 9 9 9
9 8 8 8 8 9 8 9 8 9 8 9 8 9 9 9 9 9 8 8 8
9 9 9 8 9 8 8 9 8 9 8 9 8 9 8 9 9 9 9 9 9
9 9 9 9 9 9 9 9 9 9 9 9 8 8 8 9 9 9 8 9 8
8 9 8 9 8 9 8 9 8 9 9 9 9 9 9 8 9 8 9 8 9
8 9 8 9 8 9 8 9 8 9 9 9 9 9 9 9 9 9 9 9 9
9 8 8 8 8 8 8 8 8 8 8 8 8 8 9 9 9 8 9 8 8

Referencias: <https://centrodiurnodeeltejar.org/>



Más información en:

facebook

www.centrodiurnodeeltejar.org